

9 BY 9 BUILD BRIDGES (NO. 9 AND 10)

CONNECT ALL ISLANDS INTO A SINGLE GROUP BY DRAWING HORIZONTAL OR VERTICAL LINES (BRIDGES). YOU CAN DRAW A SINGLE OR DOUBLE LINE BETWEEN EACH ISLAND (NOT MORE). THE TOTAL NUMBER OF BRIDGES THAT CONNECT AN ISLAND MATCHES THE NUMBER ON IT. THE BRIDGES MAY NOT CROSS EACH OTHER.

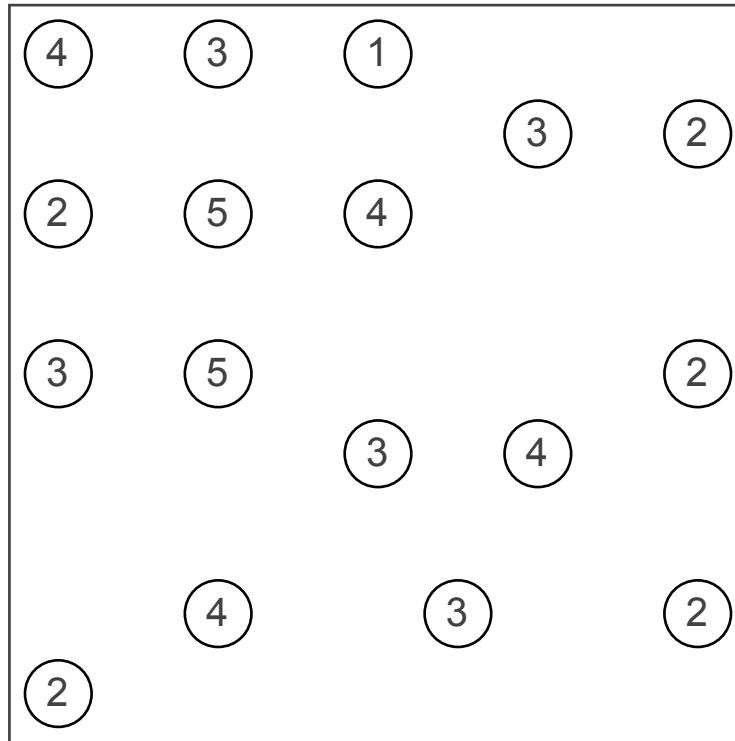

0909 BUILD BRIDGES 9

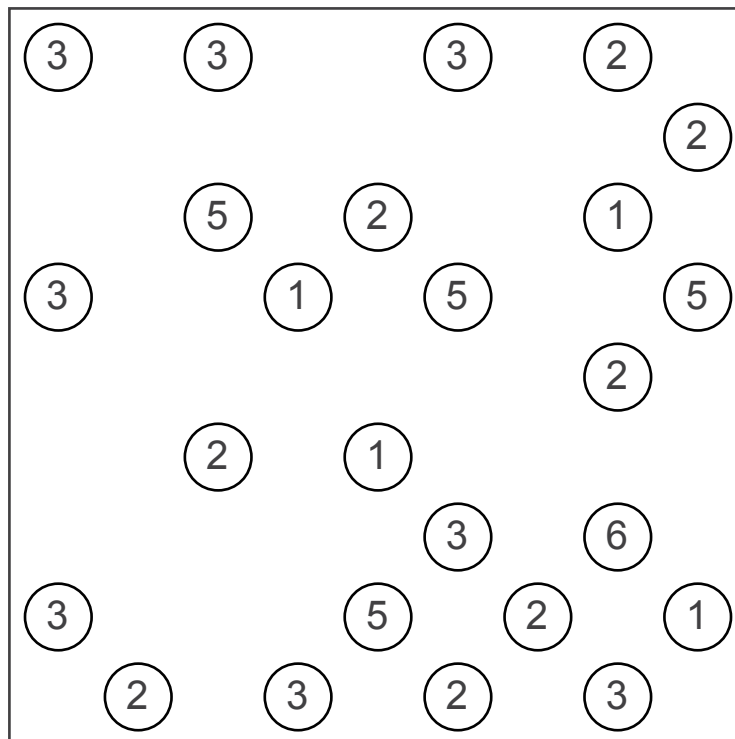

0909 BUILD BRIDGES 10

ANSWERS

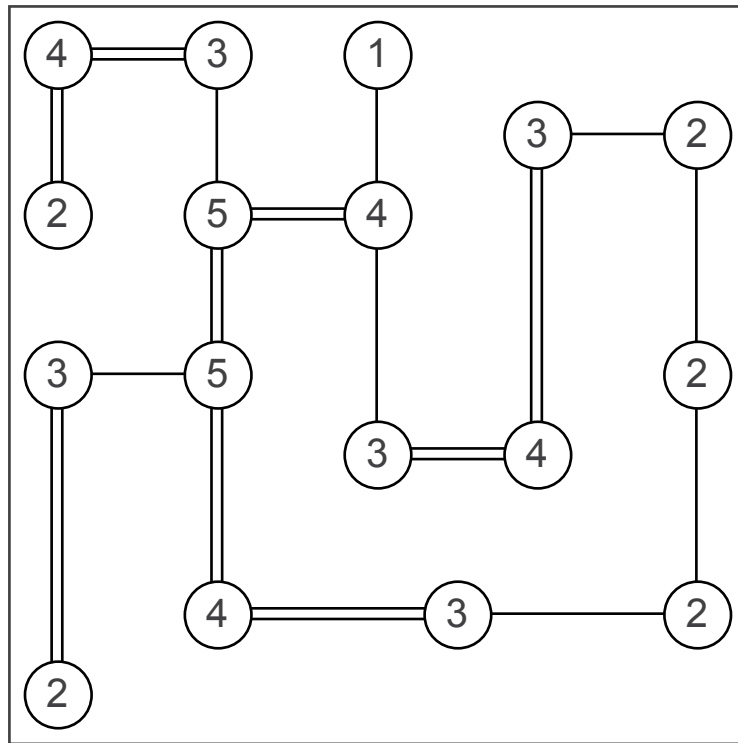

0909 BUILD BRIDGES 9

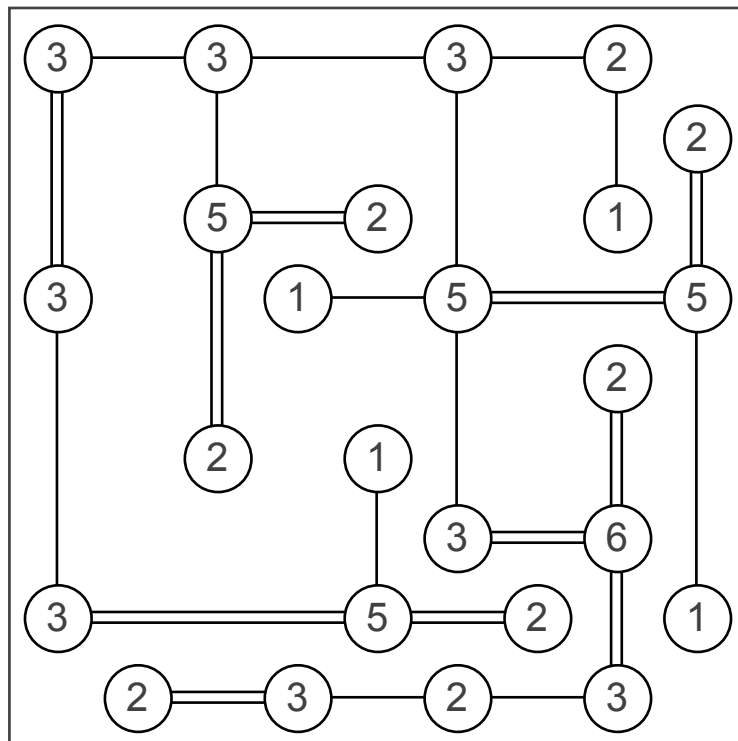

0909 BUILD BRIDGES 10